

MODBUS ENERGIEZÄHLER 3-PHASIG

Art. Nr. 200157

Der bidirektionale Energiezähler mit integrierter serieller Modbus-Schnittstelle (RS-485) ermöglichen das direkte Auslesen aller relevanten Daten, wie Energie (total und partiell), Strom und Spannung pro Phase sowie Wirk- und Blindleistung pro Phase oder als Gesamtleistung.

KENNDATEN

- 3-Phasen -Energiezähler, 3×230/400 VAC 50Hz
- Direkte Messung bis 65 A
- Anzeige von Wirkleistung, Spannung und Strom pro Phase
- Anzeige der Wirkleistung für alle Phasen
- Modbus-Schnittstelle (RTU) zum Abfragen der Daten
- Blindleistung pro Phase und/oder gesamt verfügbar
- 7-stellige Anzeige
- Genauigkeitsklasse B gemäß EN50470-3,
- Genauigkeitsklasse 1 gemäß IEC62053-21
- Bidirektional
- Einfach anbindbar an Modbus Extension mittels bereits bestehender Vorlage.

TECHNISCHE DATEN

Genauigkeitsklasse	B gemäß EN50470-3 1 gemäß IEC62053-21
Betriebsspannung	3 × 230/400 VAC, 50 Hz Toleranz -20% / +15%
Referenz-/Maximalstrom	Iref = 10 A, I _{max} = 65 A
Start-/Minimalstrom	I _{st} = 40 mA, I _{min} = 0,5 A
Leistungsaufnahme	Aktiv Phase 1: 1,1 W Phase 2: 0,6 W Phase 3: 0,6 W
Zählbereich	00'000,00...99'999,99 100'000,0...999'999,9
Display	LCD mit Hintergrundbeleuchtung, 6 mm hohe Ziffern
Anzeige ohne Netzspannung	Kondensatorgestütztes LCD. Maximal zweimal über zehn Tage

MONTAGE

Montage	Auf 35 mm Hutschiene, gemäß EN60715TH35
Anschlüsse Hauptstromkreis	Leiterquerschnitt 1,5–16 mm ² Schraubendreher Pozidrive Nr. 1 Schlitzschraubendreher Nr. 2, Anzugsmoment 1,5 bis 2 Nm
Anschlüsse Steuerstromkreis	Leiterquerschnitt max. 2,5 mm ² Schraubendreher Pozidrive Nr. 0. Schlitzschraubendreher Nr. 2, Anzugsmoment 0,8 Nm
Isolationseigenschaften	4 kV/50 Hz Test gemäß VDE0435 für Energiezähler 6 kV 1.2/50 µs Surge gemäß IEC255-4 2 kV/50 Hz Test gemäß VDE0435 für Schnittstelle Geräteschutzklasse II
Umgebungs temperatur	-25°...+55°C
Lagertemperatur	-30°...+85°C
Relative Luftfeuchtigkeit	75% ohne Betauung
Umgebungsbedingungen	Mechanische M2 Elektromagnetische E2
EMV / Störfestigkeit	Surge-Spannung gemäß IEC61000-4-5 an Hauptstromkreis 4 kV, an Modbus-Schnittstelle 1 kV Burst IEC61000-4-4 bei Hauptstromkreis 4 kV, an Modbus-Schnittstelle 1 kV, ESD gemäß IEC61000-4-2, Kontakt 8 kV, Luft 15 kV

MODBUS ENERGY METER 3-PHASE

Art. No. 200157

This bidirectional energy meter with an integrated serial Modbus interface allows direct reading of all relevant data, such as energy (total and partial), current and voltage for every phase, and active and reactive power for every phase and for the three phases.

MAIN FEATURES

- 3-phase energy meter, 3×230/400 VAC 50 Hz
- Direct measurement up to 65 A
- Display of active power, voltage and current for every phase
- Display of active power for all phases
- Modbus RTU interface to query the data
- Reactive power for every and/or all phases available
- 7-digits display
- Accuracy class B according to EN50470-3
- Accuracy class 1 according to IEC62053-21
- Bidirectional
- Easy to connect to Modbus Extension using existing template

TECHNICAL DATA

Precision class	B accord. to EN50470-3 1 accord. to IEC62053-21
Operating voltage	3 × 230/400 VAC, 50 Hz Tolerance -20% / +15%
Reference/measurement current	Iref = 10 A, I _{max} = 65 A
Starting/minimum current	I _{st} = 40 mA, I _{min} = 0,5 A
Power consumption	Active phase 1: 1,1 W phase 2: 0,6 W phase 3: 0,6 W
Counting range	00'000,00...99'999,99 100'000,0...999'999,9
Display	LCD backlight, digits 6 mm high
Display without mains power	Capacitor based LCD Max. 2 times over 10 days

MONTAGE

Mounting	On 35 mm rail, according to EN60715TH3
Terminal connections main circuit	Conductor cross-section 1.5–16 mm ² . Screwdriver Pozidrive no. 1 Slot no.2, torque 1.5–2 Nm
Terminal connect. control circuit	Conductor cross-section max. 2.5 mm ² . Screwdriver Pozidrive no. 0 Slot no.2, torque 0.8 Nm
Insulation characteristics	4 kV/50 Hz test according to VDE0435 for Energy Meter part. 6 kV 1.2/50 µs surge voltage according to IEC255-4. 2 kV/50 Hz test according to VDE435 for Interface. Device protection class II.
Ambient temperature	-25°...+55°C
Storage temperature	-30°...+85°C
Relative humidity	75% without condensation
Ambient conditions	Mechanical M2 Electromagnetic E2
EMC/interference immunity	Surge voltage according to IEC61000-4-5 at main circuit 4 kV, at Modbus interface 1 kV. Burst voltage according to IEC61000-4-4 at main circuit 4 kV, at Modbus interface 1 kV. ESD according to IEC61000-4-2, contact 8 kV, air 15 kV.

REGISTER / REGISTERS

Die Modbus Adresse (= IO-Adresse in Loxone Config) entspricht der Modbus Registernummer -1.
*Beispiel: Counter Energy Consumption - Modbus Register 28+29 entspricht der IO Adresse 27.
Da bei diesem Wert zwei 16Bit Modbus Register verwendet werden handelt es sich um einen 32Bit Datentyp (Checkbox aktivieren: 2 Register für 32-bit).*

The Modbus address (= IO address in Loxone Config) corresponds to the Modbus register -1.
Example: Counter energy consumption - Modbus register 28+29 corresponds to the IO address 27. As used in this figure two 16-bit.

Modbus registers are a 32-bit data type (Enable checkbox: Combine 2 registers for 32-bit value).

For double registers (4-5, 16-17, 28-29, 30-31) the high register is sent first (big-Endian).

Partial counter (30-31) can be reset by writing 0 in both registers in the same message.

R	Read	Write	Description	Unit
1	X		Firmware-Version	E.g.: 11 = FW 1.1
2	X		Number of supported registers	Will give 52
3	X		Number of supported flags	Will give 0
4-5	X		Baudrate	E.g.: Baudrate High = 1 Baudrate Low = 49664 1 × 65536 + 49664 = 115200 bps Will give 0
6			Not used	
7-9	X		Art. Nr.	Will give you the article number "200157"
10-14	X		Not used	Will give 0
15	X		HW vers. Modif.	E.g.: 11 = HW 1.1
16-17	X		Serial number	Unique 32 bit serial number low
18	X		Serial number	Unique 32 bit serial number high
19-21			Not used	Will give 0
22	X		Status	0 = No problem 1 = Problem with last communication request
23	X		Response timeout	ms
24	X	X ¹⁾	Modbus address	Range 1-247
25	X		Error register	0 : No error 1 : Error Phase 1 2 : Error Phase 2 3 : Error Phase 1 and 2 4 : Error Phase 3 5 : Error Phase 1 and 3 6 : Error Phase 2 and 3 7 : Error Phase 1, 2 and 3
26			Not used	Will give 0
27			Energy direction	0 is Consumption (Bezug) 4 is Feedback (Rückspeisung)
28-29	X		Counter Total energy consumption	10-2 kWh (multiplier 0.01) E.g.: Energy T1 total high = 13 Energy T1 total low = 60383 13 × 65536 + 60383 = 912351 = 9123.51 kWh
30-31	X	X	Counter Partial energy consumption	10-2 kWh (multiplier 0.01) E.g.: Energy T1 partial high = 13 Energy T1 partial low = 60383 13 × 65536 + 60383 = 912351 = 9123.51 kWh

ANSCHLUSSHEMA

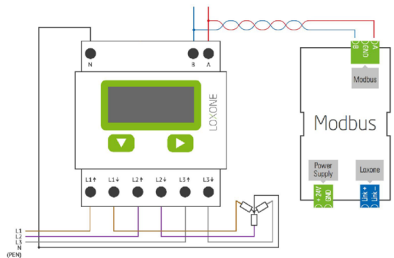

TECHNISCHE DATEN MODBUS

Protokoll	Modbus RTU gemäß IDA-Spezifikation
Bus-System	Serielle RS-485-Schnittstelle
Übertragungsrates (bit/s)	4800-9600-19'200-38'400-57'600-115'200. Die Übertragungsrates wird automatisch erkannt
Übertragungsmodus	Gerade Parität: 8 Databits, 1 Stopbit Ungerade Parität: 8 Databits, 1 Stopbit Keine Parität: 8 Databits, 2 Stopbits
Bus-Kabel	Verdrillt, geschirmt, 2 × 0,5 mm ² , max. 1200 m
Reaktionszeit	typ. 5 Zeichen max. 60 ms

- Die Kommunikation ist 30 s nach dem Einschalten bereit.
- Die Daten werden alle 10 s aktualisiert. Der Einsatz von Energiezählern in einem Bus mit intensiver Kommunikation kann die Aktualisierungszeit der Daten vergrößern.
- 247 Sensoren können am Modbus angeschlossen werden.
- Die verwendeten Register sind in der Registerliste beschrieben.

DATENÜBERTRAGUNG

- Nur «Read Holding Registers [03]/ Write Multiple Registers [16]» Anweisungen werden erkannt.
- Es können bis zu 20 Register auf einmal gelesen werden.
- Das Gerät unterstützt Broadcast-Nachrichten.
- Gemäss Modbus-Protokoll wird ein Register R bei der Übertragung als R - 1 nummeriert.
- Das Gerät hat eine Spannungsüberwachung. Bei einem Spannungsabfall werden die Register im EEPROM gespeichert. (Übertragungsrates, etc.)

AUSNAHMEREAKTIONEN

- **ILLEGAL FUNCTION [01]:** Der Funktionscode wird nicht unterstützt.
- **ILLEGAL DATA ADDRESS [02]:** Die Adresse einiger Register liegt ausserhalb des Bereichs oder es wurden mehr als 20 Register angefordert.
- **ILLEGAL DATA VALUE [03]:** Der Wert im Datenfeld für das jeweilige Register ist ungültig.

ÄNDERN DER MODBUS-ADRESSE DIREKT AM GERÄT

- Halten Sie 3 s lang **▶** gedrückt
- Im Menü erhöht **▼** die Adresse um 10, **▶** erhöht die Adresse um 1
- Wenn die gewünschte Adresse erreicht ist, warten Sie bis die Hauptanzeige wieder erscheint

CONNECTION

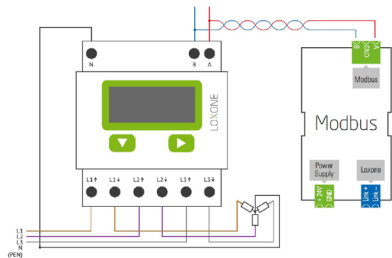

TECHNICAL DATA MODBUS

Protocol	Modbus RTU according to IDA specification
Bus system	RS-485 Serial line
Transmission rate (bps)	4800-9600-19'200-38'400-57'600-115'200. The transmission Baud rate is automatically detected.
Bit settings	Even parity: 8 data bits, 1 stop bit Odd parity: 8 data bits, 1 stop bit No parity: 8 data bits, 2 stop bits
Bus cable	Twisted, shielded, 2 × 0,5 mm ² , max. 1200 m
Response time	typ. 5 character times max. 60 ms

- The communication is ready 30 s after the Power On.
- Refresh time for the data is 10 s.
- The use of energy meters in a bus with intensive communication can increase the data refresh time.
- 247 devices can be connected to the Modbus.
- For a description of the registers see the register list page

DATA TRANSMISSION

- Only «Read Holding Registers [03]/ Write Multiple Registers [16]» instructions are recognised.
- Up to 20 registers can be read at once.
- The device supports broadcast messages.
- In accordance with the Modbus protocol, a register R is numbered as R - 1 when transmitted.
- The device has a voltage monitoring system. In cases of voltage loss, registers are stored in EEPROM (transmission rate, etc.)

EXCEPTION RESPONSES

- **ILLEGAL FUNCTION [01]:** The function code is not implemented.
- **ILLEGAL DATA ADDRESS [02]:** The address of some requested registers is out of range or more than 20 registers have been requested.
- **ILLEGAL DATA VALUE [03]:** The value in the data field is invalid for the referenced register.

CHANGE THE MODBUS ADDRESS DIRECT ON DEVICE

- Press for 3 secs on **▶** touch
- In menu, **▼** increase address by 10, **▶** increase by 1
- Once the desired address is selected wait for the root menu to come back.

R	Read	Write	Description	Unit
32-33	X		Counter Total energy feedback	10 ⁻² kWh (multiplier 0.01) E.g.: Energy T2 total high = 13 Energy T2 total low = 60383 13 × 65536 + 60383 = 912351 = 9123.51 kWh
34-35	X	X	Counter Partial energy feedback	10 ⁻² kWh (multiplier 0.01) E.g.: Energy T2 partial high = 13 Energy T2 partial low = 60383 13 × 65536 + 60383 = 912351 = 9123.51 kWh
36	X		URMS Phase 1 Effective voltage of Phase 1	V E.g.: 230 = 230 V
37	X		IRMS Phase 1 Effective current of Phase 1	10 ⁻¹ A (multiplier 0.1) E.g.: 314 = 31.4 A
38	X		PRMS Phase 1 Effective active power of Phase 1	10 ⁻² kW (multiplier 0.01) E.g.: 1545 = 15.45 kW
39	X		QRMS Phase 1 Effective reactive power of Phase 1	10 ⁻² kvar (multiplier 0.01) E.g.: 1545 = 15.45 kvar
40	X		cos phi Phase 1	10 ⁻² (multiplier 0.01) E.g.: 67 = 0.67
41	X		URMS Phase 2 Effective voltage of Phase 2	V E.g.: 230 = 230 V
42	X		IRMS Phase 2 Effective current of Phase 2	10 ⁻¹ A (multiplier 0.1) E.g.: 314 = 31.4 A
43	X		PRMS Phase 2 Effective active power of Phase 2	10 ⁻² kW (multiplier 0.01) E.g.: 1545 = 15.45 kW
44	X		QRMS Phase 2 Effective reactive power of Phase 2	10 ⁻² kvar (multiplier 0.01) E.g.: 1545 = 15.45 kvar
45	X		cos phi Phase 2	10 ⁻² (multiplier 0.01) E.g.: 67 = 0.67
46	X		URMS Phase 3 Effective voltage of Phase 3	V E.g.: 230 = 230 V
47	X		IRMS Phase 3 Effective current of Phase 3	10 ⁻¹ A (multiplier 0.1) E.g.: 314 = 31.4 A
48	X		PRMS Phase 3 Effective active power of Phase 3	10 ⁻² kW (multiplier 0.01) E.g.: 1545 = 15.45 kW
49	X		QRMS Phase 3 Effective reactive power of Phase 3	10 ⁻² kvar (multiplier 0.01) E.g.: 1545 = 15.45 kvar
50	X		cos phi Phase 3	10 ⁻² (multiplier 0.01) E.g.: 67 = 0.67
51	X		PRMS total Effective active power of all phases	10 ⁻² kW (multiplier 0.01) E.g.: 1545 = 15.45 kW
52	X		QRMS total Effective reactive power of all phases	10 ⁻² kvar (multiplier 0.01) E.g.: 1545 = 15.45 kvar

¹⁾ The Modbus address register is not writable with a broadcast message.

ERROR DISPLAY

Example: Connection error at L3

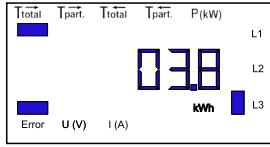

Example: Connection error at L1 and L3

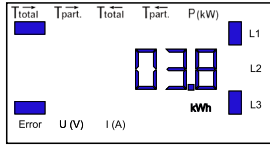

DIMENSIONS

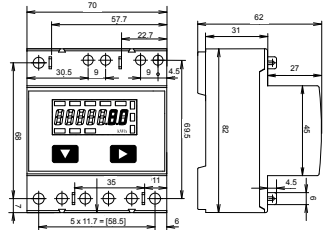

DISPLAY ELEMENTS, DIRECT MEASUREMENT

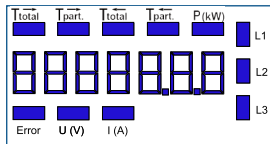

- T→ total Shows the total consumption T→
- T→ part. Shows the partial consumption T→, this value is resettable
- T← total Shows the total production T←
- T← part. Shows the partial production T←, this value is resettable
- P (kW) Indicates the instantaneous power per phase or all phases
"→" = Consumption (P positive)
"←" = Production (P negative)
- U (V) Shows the voltage per phase
- I (A) Shows the current per phase
- kWh Shows the unit kWh for consumption display
- L1/L2/L3 For P, U, I or error message display
- Error In the absence of phase. The corresponding phase is also displayed

- T→ total Zeigt den Bezug Total T→
- T→ part. Zeigt den partiellen Bezug bei T→, dieser Wert ist rückstellbar
- T← total Zeigt die Rückspeisung Total T←
- T← part. Zeigt die partielle Rückspeisung Total T←, dieser Wert ist rückstellbar
- P (kW) Zeigt die momentane Leistung pro Phase oder für alle Phasen
Strom "→" = Bezug (P positiv)
Strom "←" = Rückspeisung (P negativ)
- U (V) Zeigt die Spannung pro Phase
- I (A) Zeigt den Strom pro Phase
- kWh Zeigt die Einheit kWh bei Verbrauchs- oder Rückspeiseanzeige
- L1/L2/L3 Bei P-, U-, I- oder Error-Anzeige wird die entsprechende Phase angezeigt
- Error Bei fehlender Phase. Die entsprechende Phase wird zusätzlich angezeigt.

MENÜ, UM DIE WERTE AUF DER LCD ANZUZEIGEN MENU TO DISPLAY THE VALUES ON THE LCD

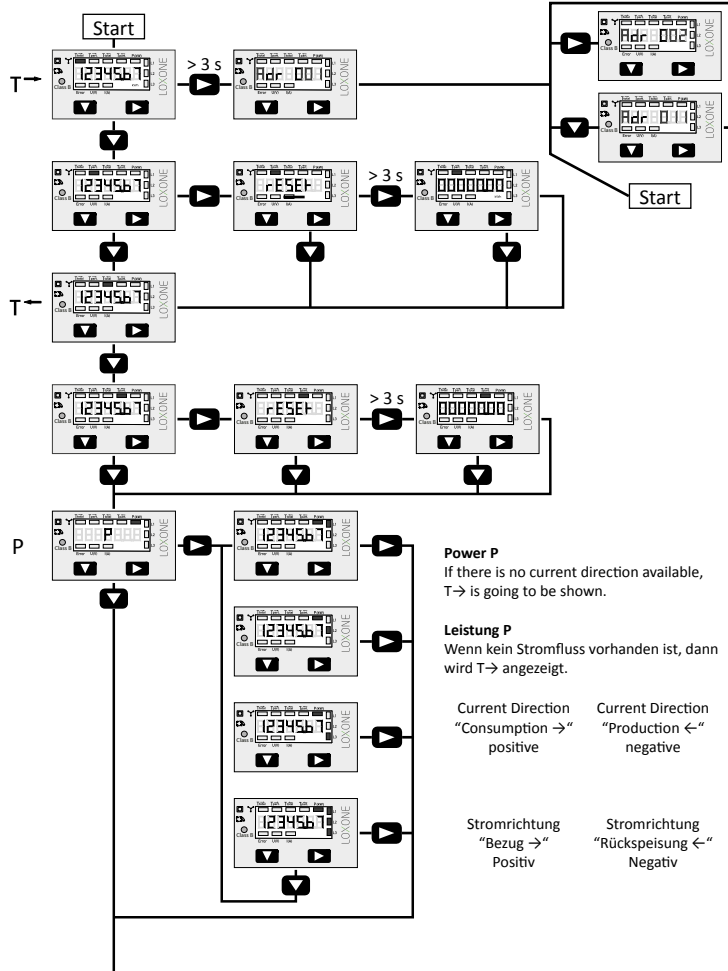

Power P
If there is no current direction available, T→ is going to be shown.

Leistung P
Wenn kein Stromfluss vorhanden ist, dann wird T→ angezeigt.

Current Direction "Consumption →" positive Current Direction "Production ←" negative

Stromrichtung "Bezug →" Positiv Stromrichtung "Rückspeisung ←" Negativ

